

TYPE 110  
SAME AS TYPE 108  
EXCEPT AS SHOWN

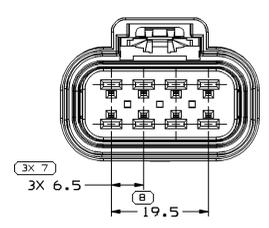

TYPE 208  
SAME AS TYPE 108  
EXCEPT AS SHOWN

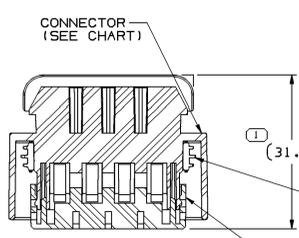

SECTION A-A

SYMBOL DEFINITION		TOTAL NO OF INSPECTIONS REQUIRED		MISSING SYMBOLS	
A DIMENSION WITHOUT AN INSPECTION REPORT SYMBOL DOES NOT REQUIRE INSPECTION. IT MAY BE CONTROLLED ON THE INDIVIDUAL COMPONENT DRAWING.		70		NO MISSING SYMBOL NUMBER	
		LAST NO. USED	30		

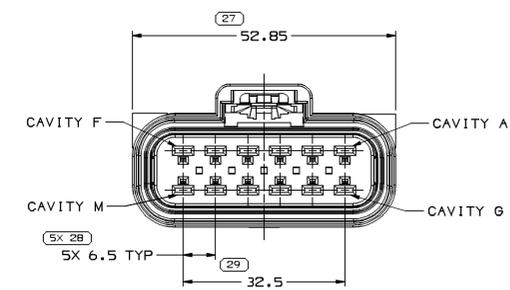
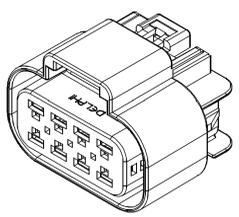

TYPE 112  
SAME AS TYPE 108  
EXCEPT AS SHOWN

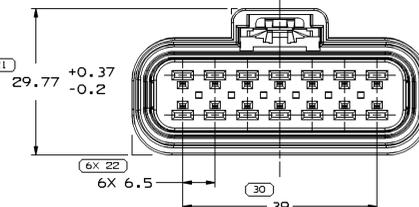

TYPE 214  
SAME AS TYPE 114  
EXCEPT AS SHOWN

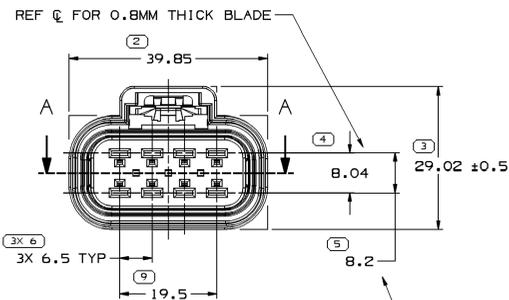

TYPE 108

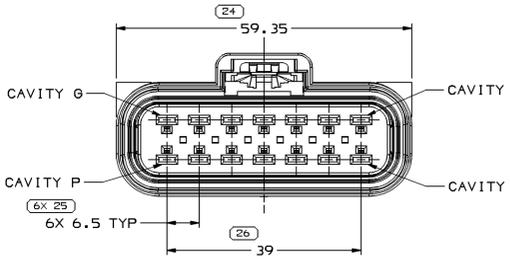

TYPE 114  
SAME AS TYPE 108  
EXCEPT AS SHOWN

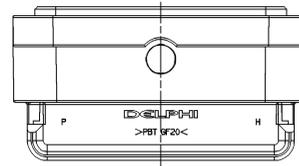

TYPE 210  
SAME AS TYPE 214  
EXCEPT AS SHOWN

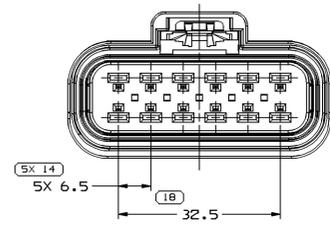

TYPE 212  
SAME AS TYPE 214  
EXCEPT AS SHOWN

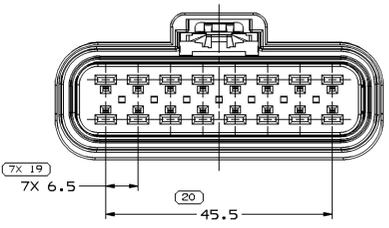

TYPE 216  
SAME AS TYPE 214  
EXCEPT AS SHOWN

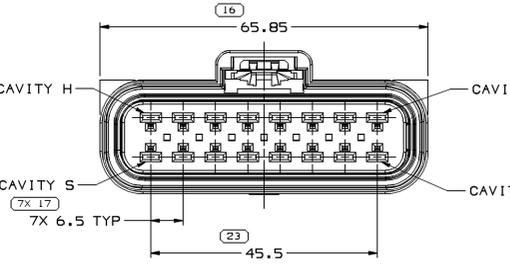

TYPE 116  
SAME AS TYPE 108  
EXCEPT AS SHOWN

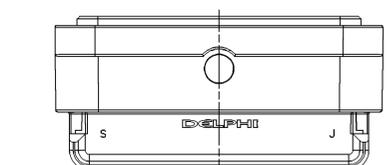
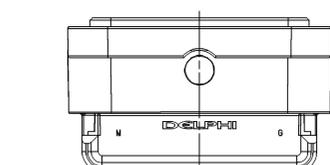
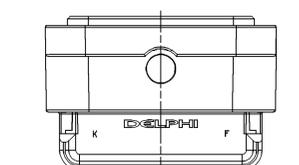

NOTES

- UNLESS OTHERWISE SPECIFIED AND/OR INDICATED:  
DIMENSIONS ARE TO FACE OF VIEW SHOWN AND AUTOMATICALLY ROUNDED BY COMPUTER FOR INSPECTION. (SEE MATH MODEL FOR PRECISE DIMENSIONS.) FOR ALL OTHER DIMENSIONS NOT SHOWN BUT REQUIRED FOR TOOL BUILD, SEE MATH MODEL FOR PRECISE TOOL PATH DATA.
- SEALING CODE 4 - DESIGN WILL MEET REQUIREMENTS OF SAE/USCAR-2 CONNECTOR SYSTEM ENVIRONMENTAL TEST FLOWCHART (PRESSURE/VACUUM AND SUBMERSION).
- ASSEMBLIES WITH 12 CAVITIES OR MORE, MATING FORCE WILL EXCEED 80N.
- THIS PRODUCT IS NOT CATEGORIZED AS AN APPEARANCE ITEM, MINOR IMPERFECTIONS INCLUDING, BUT NOT LIMITED TO, FLOW MARKS, COLOR BLEMISHES, GATE VESTIGES, AND SOFT FLASH THAT DO NOT AFFECT THE FIT, FORM, OR FUNCTION OF THE PART ARE PERMISSIBLE PER DPNP-4.7-CS-01.
- FOR APPLICATION DATA SEE THE INDIVIDUAL APPLICATION DRAWINGS.

PART NO	ITEM ID	REV	N/P	RECOMMENDED USAGE	TYPE	CONN	MATERIAL RECYCLING CODE	COLOR	PLR	CONN SEAL	CAVITIES
13672062	-	01	AA	-	212	13672061	POLYESTER COMPOUND	BLACK	15326912 / ID406337	15326913 / ID406338	12
13658980	-	01	AA	-	216	13658979	POLYESTER COMPOUND	BLACK	15326664 / ID406352	15326665 / ID406353	16
13672060	-	01	AA	-	210	13672059	POLYESTER COMPOUND	BLACK	15326658 / ID406330	15326659 / ID406332	10
13540547	-	01	AD	-	214	13540546	POLYESTER COMPOUND	BLACK	15326919 / ID406343	15326920 / ID406344	14
13538370	-	01	AC	-	208	13534968	POLYESTER COMPOUND	BLACK	15326652 / ID406319	15326653 / ID406320	8
15326917	ID406341	02	AF	DO NOT PROLIFERATE REPLACED BY 13540547	114	15326916 / ID406345	POLYAMIDE COMPOUND	BLACK	15326919 / ID406343	15326920 / ID406344	14
15326910	ID406335	02	AF	-	112	15326909 / ID406339	POLYAMIDE COMPOUND	BLACK	15326912 / ID406337	15326913 / ID406338	12
15326666	ID406349	02	AF	-	116	15326662 / ID406350	POLYAMIDE COMPOUND	BLACK	15326664 / ID406352	15326665 / ID406353	16
15326660	ID406334	02	AF	-	110	15326656 / ID406328	POLYAMIDE COMPOUND	BLACK	15326658 / ID406330	15326659 / ID406332	10
15326654	ID406322	02	AG	DO NOT PROLIFERATE REPLACED BY 13538370	108	15326650 / ID406317	POLYAMIDE COMPOUND	BLACK	15326652 / ID406319	15326653 / ID406320	8

DIMENSIONAL RANGE (MM)	TOLERANCE	CHART REF
FROM > 0	> 0.25	1
> 0.25	> 0.30	2
> 0.30	> 0.40	3
> 0.40	> 0.50	4
> 0.50	> 0.63	5
> 0.63	> 0.80	6
> 0.80	> 1.00	7
> 1.00	> 1.25	8
> 1.25	> 1.60	9
> 1.60	> 2.00	10
> 2.00	> 2.50	11
> 2.50	> 3.15	12
> 3.15	> 4.00	13
> 4.00	> 5.00	14
> 5.00	> 6.30	15
> 6.30	> 8.00	16
> 8.00	> 10.00	17
> 10.00	> 12.50	18
> 12.50	> 16.00	19
> 16.00	> 20.00	20
> 20.00	> 25.00	21
> 25.00	> 31.50	22
> 31.50	> 40.00	23
> 40.00	> 50.00	24
> 50.00	> 63.00	25
> 63.00	> 80.00	26
> 80.00	> 100.00	27
> 100.00	> 125.00	28
> 125.00	> 160.00	29
> 160.00	> 200.00	30
> 200.00	> 250.00	31
> 250.00	> 315.00	32
> 315.00	> 400.00	33
> 400.00	> 500.00	34
> 500.00	> 630.00	35
> 630.00	> 800.00	36
> 800.00	> 1000.00	37
> 1000.00	> 1250.00	38
> 1250.00	> 1600.00	39
> 1600.00	> 2000.00	40

DATE	STG	REV	N/P	ZONE	REVISION HISTORY	AUTH	DR	APV/D	APV/D
25AU99	R	02	-	-	CLEARED REVISION COLUMN PART DRAWING UPDATED	196586	DRR	DRR	DRR
190C99	R	03	-	-	ALL PARTS - REVISED GRAPHICS	196725	LMM	RMM	SMN
14JL03	R	04	-	-	ALL PARTS - REVISED CHART TO SHOW MATING TPA P/Ns: REVISED MATING COMPONENT NOTE, ADDED CPA P/N	242960	ADK	ADK	SMN
22SE05	R	05	-	-	13538370 & 13540547 - RELEASED	272748	LMB	LMB	BR
09MR06	R	06	-	-	ALL PARTS - TERMINAL 15304720 WAS 15304718, CABLE SEAL 15366067 WAS 121912381 15326654 - 39.85 WAS 39.9, 29.02 +/- 0.5 WAS 29; 15326660 - 46.37 WAS 46.4; 15326666 - 65.85 WAS 65.91; 15326910 - 52.85 WAS 52.91; 15326917 - 59.35 WAS 59.4; 13538370 - UPDATED PD ATTRIBUTES; 13540547 - REVISED DELPHI LOGO & VIEW TYPE LABEL	277561	MAC	MAC	SMN
26AP06	R	07	-	-	13540547 - 29.77 +/- 0.37/-0.2 WAS 29.77	279991	JPH	FKV	RWR
17MY06	R	08	-	-	ALL PARTS - UPDATED PDM ATTRIBUTES; 15326654 - RESTRICTED AND ADDED REPLACED BY COLUMN IN CHART	280598	CCV	JVM	RWR
23MR07	R	09	-	-	15326654, 15326660, 15326666, 15326910 & 15326917 - UPDATED PDM ATTRIBUTES	400960	JBD	JVM	661
20FE08	R	10	-	-	ALL PARTS - ADDED COL TO CHART FOR "RECOMMENDED USAGE", APPLICATION DATA NOTE & APPEARANCE ITEM NOTE; REMOVED COL FROM CHART FOR "REPLACED BY" PART ACCEPTS NOTE; MATING CONFIGURATION NOTE, REFERENCE MATING NOTE, MATING TPA COL., CONF18 REQ COL., MATING CONN ASM COL. AND REVISED MAT'L CALLOUT TO GENERIC CALLOUT & MATERIAL RECYCLING CODE LABEL; 15326654 - REMOVED RESTRICTED STATUS; 13672060, 13658980 & 13672062 - RELEASED; 15326654 & 15326917 - ADDED NOTE FOR RECOMMENDED USAGE	402837	JTV	AUG	RWR
28AU12	R	11	-	-	ALL PARTS - REVISED MATING FORCE NOTE AND ADDED CAVITIES COLUMN IN CHART	419436	APB	JAA	DAF

**DELPHI**  
DELPHI PACKARD ELECTRICAL/ELECTRONIC ARCHITECTURE  
WARREN, OH  
COPYRIGHT 1997 DELPHI CORPORATION AND/OR ITS AFFILIATES. ALL RIGHTS RESERVED.  
THIS DRAWING IS THE PROPERTY OF DELPHI CORPORATION. THE REPRODUCTION, DISTRIBUTION AND UTILIZATION OF THIS DOCUMENT OR ITS RELATED CAD DATA, AS WELL AS COMBINATION OF ANY CONTENT TO OTHERS, WITHOUT EXPRESS AUTHORIZATION IS PROHIBITED.

DATE: 09JL97  
OR: B. NABY  
APV01: M. MCCALL  
APV02: W. MCCALL  
APV03: S.A. NORLING  
APV04:  
APV05:

THIS DOCUMENT IS IN ACCORDANCE WITH ASME Y14.5M-1994 AS MODIFIED BY THE 2003 SUPPLEMENT AND TELEPHONIC ADDENDUM-2001. SEPARATE PATTERNS OF FEATURES MAY BE SHOWN SEPARATELY, REGARDLESS OF DATA REFERENCES.

UNLESS OTHERWISE SPECIFIED  
ALL DIMENSIONS ARE IN MILLIMETERS

THIRD ANGLE PROJECTION  
DO NOT SCALE  
USE MATH DATA

DRAWING NUMBER: 15326672  
SHEET NO: 1 OF 1  
STG: R  
REV: 11