

PLEASE CHECK WWW.MOLEX.COM FOR LATEST PART INFORMATION

Part Number: **0190190012**
Status: **Active**
Overview: Standard Quick-Disconnect Terminals
Description: Avikrimp Quick Disconnect, Female, for 18-22 (0.80-0.35mm²) Wire, Box, Tab 6.35 x 0.81mm

Documents:

[Drawing \(PDF\)](#) [Product Specification PS-19902-014-001 \(PDF\)](#)
[Product Specification PS-19902-011-001 \(PDF\)](#) [RoHS Certificate of Compliance \(PDF\)](#)
[Product Specification PS-19902-013-001 \(PDF\)](#)

Agency Certification

CSA LR18689
 UL E79133

General

Product Family Quick Disconnects
 Series 19019
 Crimp Quality Equipment Yes
 Insulated Partial
 Overview Standard Quick-Disconnect Terminals
 Product Name Avikrimp
 Type Quick Disconnect
 UPC 800753037939

Physical

Barrel Type Closed
 Color - Resin Red
 Flammability 94V-2
 Gender Female
 Glow-Wire Capable No
 Insulation Nylon (PA)
 Lock to Mating Part None
 Material - Metal Brass
 Material - Plating Mating Tin
 Material - Plating Termination Tin
 Net Weight 0.876/g
 Orientation Straight
 Packaging Type Bag
 Polarized to Mating Part No
 Tab Thickness 0.81mm
 Tab Width 6.35mm
 Temperature Range - Operating -65°C to +105°C
 Wire Insulation Diameter 2.90mm max.
 Wire Size AWG 18, 20, 22

Electrical

Voltage - Maximum 300V

Solder Process Data

Lead-free Process Capability N/A

Material Info

Engineering Number AA-8140

Reference - Drawing Numbers

Product Specification PS-19902-011-001, PS-19902-013-001, PS-19902-014-001

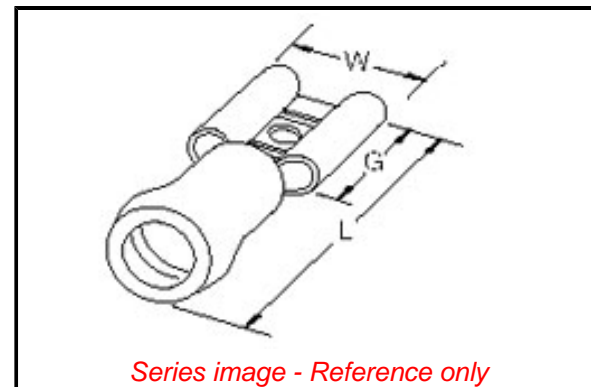

EU ELV

Not Relevant

EU RoHS

Compliant

REACH SVHC

Not Contained Per -ED/01/2018 (15 January 2018)

Halogen-Free

Status

Not Low-Halogen

Need more information on product environmental compliance?

Email productcompliance@molex.com
 Please visit the [Contact Us](#) section for any non-product compliance questions.

China ROHS

ELV

RoHS Phthalates

Green Image

Not Relevant

Not Contained

Search Parts in this Series

19019 Series

This document was generated on 06/12/2018

PLEASE CHECK WWW.MOLEX.COM FOR LATEST PART INFORMATION