

**Specifications:**

Sound level Category	Medium Sound Level
Mode of Operation	Continuous tone
Mounting	Panel (see note B)
Voltage Rating	6 to 28 Vdc
Frequency	2900 Hz ±500 Hz
Loudness (Min. Voltage)	68 dB(A) min. @ 2 FT and 6 Vdc
Loudness (Max Voltage)	80 dB(A) min. @ 2 FT and 28 Vdc
Current Draw	3 mA Max @ 6 Vdc
Current Draw	18 mA Max @ 28 Vdc
Storage Temperature	-40°C to +85°C
Operating Temperature	-30°C to +65°C
Weight (Typical)	1.5 oz (42 g)
Housing	6/6 Nylon, Color Black
Options	For other options contact factory

**Dimensions:** Inches (mm)

**UL Recognized** 

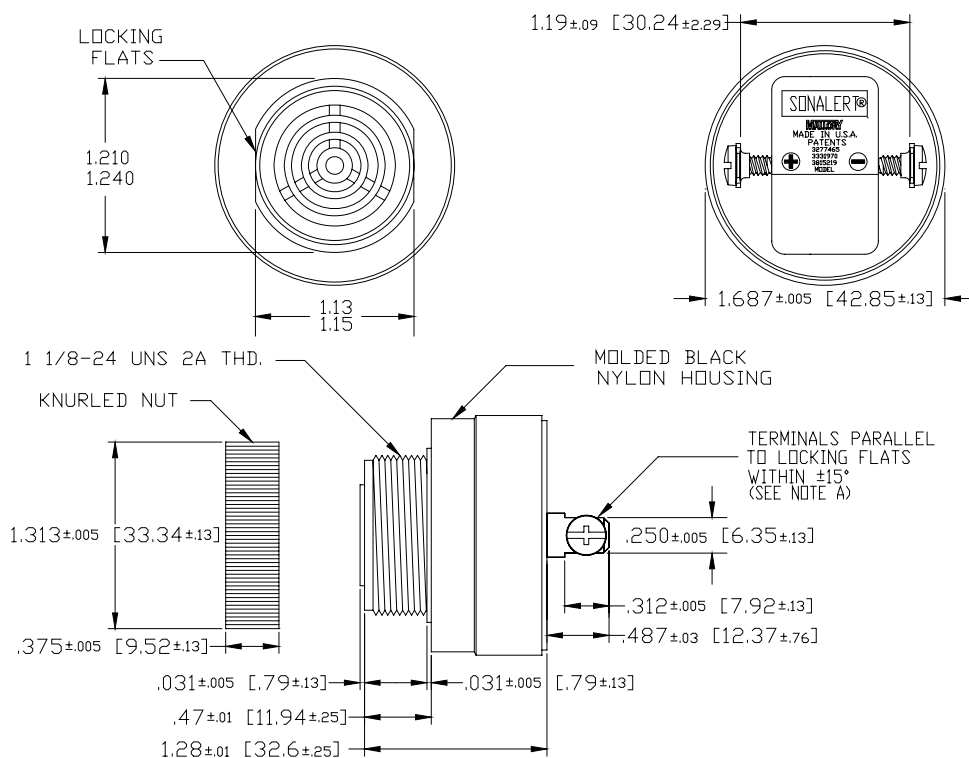

NOTE A: TERMINALS-.032 BRASS TIN PLATED, TAPPED FOR #6-32 SCREW. TWO #6-32 NICKEL PLATED BRASS SCREWS INCLUDED. WILL ACCEPT 1/4" QUICK CONNECT.

NOTE B: MOUNTING- REMOVE BLACK PLASTIC NUT AND INSERT THREADED FRONT THROUGH 1.25" HOLE PUNCHED IN PANEL, IF ORIENTATION IS NEEDED, NOTE LOCKING FLATS ON DRAWING. SCREW NUT BACK ON. DO NOT OVERTIGHTEN.